

Internet Engineering Task Force (IETF)
Request for Comments: 7865
Category: Standards Track
ISSN: 2070-1721

R. Ravindranath
Cisco Systems
P. Ravindran
Nokia Networks
P. Kyzivat
Huawei
May 2016

Session Initiation Protocol (SIP) Recording Metadata

Abstract

Session recording is a critical requirement in many communications environments, such as call centers and financial trading organizations. In some of these environments, all calls must be recorded for regulatory, compliance, and consumer protection reasons. The recording of a session is typically performed by sending a copy of a media stream to a recording device. This document describes the metadata model as viewed by the Session Recording Server (SRS) and the recording metadata format.

Status of This Memo

This is an Internet Standards Track document.

This document is a product of the Internet Engineering Task Force (IETF). It represents the consensus of the IETF community. It has received public review and has been approved for publication by the Internet Engineering Steering Group (IESG). Further information on Internet Standards is available in Section 2 of RFC 7841.

Information about the current status of this document, any errata, and how to provide feedback on it may be obtained at <http://www.rfc-editor.org/info/rfc7865>.

Copyright Notice

Copyright (c) 2016 IETF Trust and the persons identified as the document authors. All rights reserved.

This document is subject to BCP 78 and the IETF Trust's Legal Provisions Relating to IETF Documents (<http://trustee.ietf.org/license-info>) in effect on the date of publication of this document. Please review these documents carefully, as they describe your rights and restrictions with respect to this document. Code Components extracted from this document must include Simplified BSD License text as described in Section 4.e of the Trust Legal Provisions and are provided without warranty as described in the Simplified BSD License.

Table of Contents

1. Introduction	3
2. Terminology	3
3. Definitions	4
4. Metadata Model	5
5. Recording Metadata Format from SRC to SRS	6
5.1. XML Data Format	7
5.1.1. Namespace	7
5.1.2. 'recording' Element	7
6. Recording Metadata Classes	7
6.1. Recording Session	8
6.1.1. Attributes	8
6.1.2. Linkages	9
6.2. Communication Session Group	9
6.2.1. Attributes	10
6.2.2. Linkages	10
6.3. Communication Session	11
6.3.1. Attributes	11
6.3.2. Linkages	12
6.4. CS-RS Association	13
6.4.1. Attributes	14
6.4.2. Linkages	14
6.5. Participant	14
6.5.1. Attributes	15
6.5.2. Linkages	15
6.6. Participant-CS Association	16
6.6.1. Attributes	17
6.6.2. Linkages	17
6.7. Media Stream	18
6.7.1. Attributes	18
6.7.2. Linkages	19

6.8. Participant-Stream Association	19
6.8.1. Attributes	20
6.8.2. Linkages	20
6.9. Syntax of XML Elements for Date and Time	21
6.10. Format of Unique ID	21
6.11. Metadata Version Indicator	21
7. Recording Metadata Snapshot Request Format	22
8. SIP Recording Metadata Examples	23
8.1. Complete SIP Recording Metadata Example	23
8.2. Partial Update of Recording Metadata XML Body	25
9. XML Schema Definition for Recording Metadata	26
10. Security Considerations	30
11. IANA Considerations	31
11.1. SIP Recording Metadata Schema Registration	31
12. References	31
12.1. Normative References	31
12.2. Informative References	32
Acknowledgements	34
Authors' Addresses	34

1. Introduction

Session recording is a critical requirement in many communications environments, such as call centers and financial trading organizations. In some of these environments, all calls must be recorded for regulatory, compliance, and consumer protection reasons. The recording of a session is typically performed by sending a copy of a media stream to a recording device. This document focuses on the recording metadata, which describes the Communication Session (CS). The document describes a metadata model as viewed by the Session Recording Server (SRS) and the recording metadata format, the requirements for which are described in [RFC6341] and the architecture for which is described in [RFC7245].

2. Terminology

The key words "MUST", "MUST NOT", "REQUIRED", "SHALL", "SHALL NOT", "SHOULD", "SHOULD NOT", "RECOMMENDED", "MAY", and "OPTIONAL" in this document are to be interpreted as described in [RFC2119]. This document only uses these key words when referencing normative statements in existing RFCs.

3. Definitions

Metadata model: A metadata model is an abstract representation of metadata using a Unified Modeling Language (UML) [UML] class diagram.

Metadata classes: Each block in the model represents a class. A class is a construct that is used as a blueprint to create instances (called "objects") of itself. The description of each class also has a representation of its attributes in a second compartment below the class name.

Attributes: Attributes represent the elements listed in each of the classes. The attributes of a class are listed in the second compartment below the class name. Each instance of a class conveys values for the attributes of that class. These values get added to the recording's metadata.

Linkages: Linkages represent the relationship between the classes in the model. Each linkage represents a logical connection between classes (or objects) in class diagrams (or object diagrams). The linkages used in the metadata model of this document are associations.

This document also refers to the terminology defined in [RFC6341].

4. Metadata Model

Metadata is the information that describes recorded media and the CS to which they relate. The diagram below shows a model for metadata as viewed by an SRS.

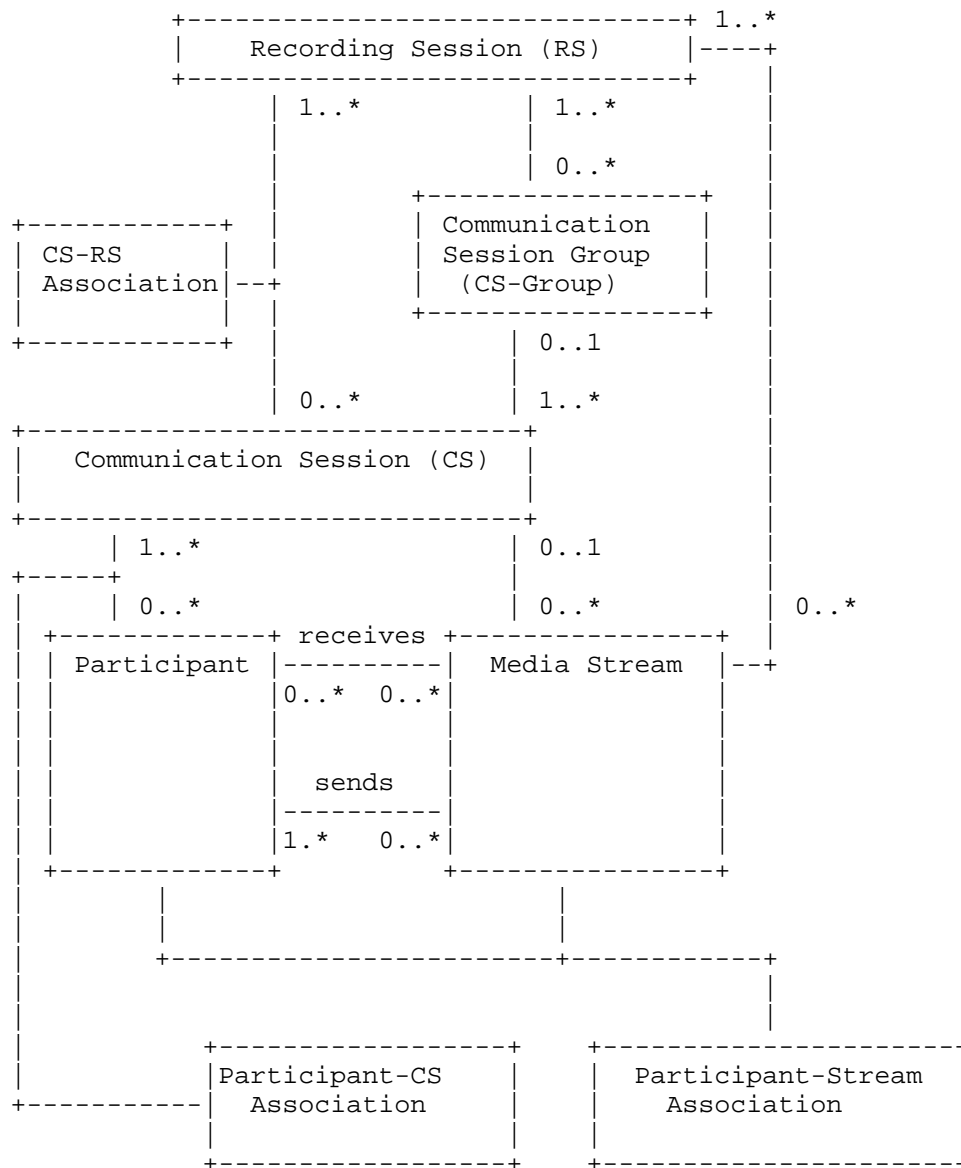

The metadata model is a class diagram in UML. The model describes the structure of metadata in general by showing the classes, their attributes, and the relationships among the classes. Each block in the model above represents a class. The linkages between the classes represent the relationships, which can be associations or compositions. The metadata is conveyed from the Session Recording Client (SRC) to the SRS.

The model allows metadata describing CSs to be communicated to the SRS as a series of snapshots, each representing the state as seen by a single SRC at a particular instant in time. Metadata changes from one snapshot to another reflect changes in what is being recorded. For example, if a participant joins a conference, then the SRC sends the SRS a snapshot of metadata having that participant information (with attributes like (Name, AoR) tuple and associate-time). (Note: "AoR" means "Address-of-Record".)

Some of the metadata is not required to be conveyed explicitly from the SRC to the SRS, if it can be obtained contextually by the SRS (e.g., from SIP or Session Description Protocol (SDP) signaling). For example, the 'label' attribute within the 'stream' XML element references an SDP "a=label" attribute that identifies an m-line within the Recording Session (RS) SDP. The SRS would learn the media properties from the media line.

5. Recording Metadata Format from SRC to SRS

This section gives an overview of the recording metadata format. Some data from the metadata model is assumed to be made available to the SRS through SDP [RFC4566], and therefore this data is not represented in the XML document format specified in this document. SDP attributes describe different media formats like audio and video. The other metadata attributes, such as participant details, are represented in a new recording-specific XML document of type 'application/rs-metadata+xml'. The SDP "label" attribute [RFC4574] provides an identifier by which a metadata XML document can refer to a specific media description in the SDP sent from the SRC to the SRS.

The XML document format can be used to represent either the complete metadata or a partial update to the metadata. The latter includes only elements that have changed compared to the previously reported metadata.

5.1. XML Data Format

Every recording metadata XML document sent from the SRC to the SRS contains a 'recording' element. The 'recording' element acts as a container for all other elements in this XML document. A 'recording' object is an XML document. It has the XML declaration and contains an encoding declaration in the XML declaration, e.g., "<?xml version="1.0" encoding="UTF-8"?>". If the charset parameter of the MIME content type declaration is present and it is different from the encoding declaration, the charset parameter takes precedence.

Every application conforming to this specification MUST accept the UTF-8 character encoding to ensure minimal interoperability.

Syntax and semantic errors in an XML document should be reported to the originator, using application-specific mechanisms.

5.1.1. Namespace

With the following URN, this document defines a new namespace URI for elements defined herein:

```
urn:ietf:params:xml:ns:recording:1
```

5.1.2. 'recording' Element

The 'recording' element MUST contain an xmlns namespace attribute with a value of urn:ietf:params:xml:ns:recording:1. Exactly one 'recording' element MUST be present in every recording metadata XML document.

A 'recording' element MAY contain a 'dataMode' element indicating whether the XML document is a complete document or a partial update. If no 'dataMode' element is present, then the default value is "complete".

6. Recording Metadata Classes

This section describes each class of the metadata model and the attributes of each class. This section also describes how different classes are linked and the XML element for each of them.

6.1. Recording Session

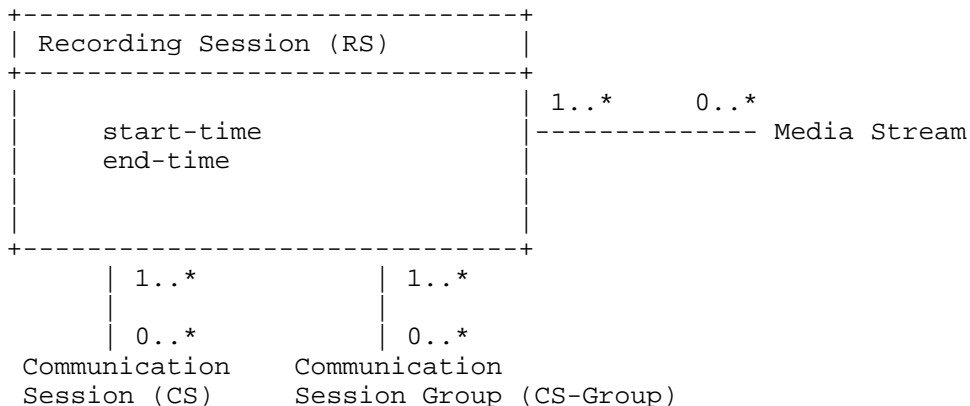

Each instance of an RS class, namely the RS object, represents a SIP session created between an SRC and SRS for the purpose of recording a CS.

The RS object is represented in the XML schema using the 'recording' element, which in turn relies on the SIP/SDP session with which the XML document is associated to provide the attributes of the RS element.

6.1.1. Attributes

An RS class has the following attributes:

- o start-time - Represents the start time of an RS object.
- o end-time - Represents the end time of an RS object.

'start-time' and 'end-time' attribute values are derivable from the Date header (if present in the SIP message) in the RS. In cases where the Date header is not present, 'start-time' is derivable from the time at which the SRS receives the notification of the SIP message to set up the RS, and 'end-time' is derivable from the time at which the SRS receives a disconnect on the RS SIP dialog.

6.1.2. Linkages

Each instance of an RS has:

- o Zero or more instances of CS-Groups.
- o Zero or more instances of CS objects.
- o Zero or more instances of MediaStream objects.

Zero instances of CSs and CS-Groups in a 'recording' element are allowed to accommodate persistent recording scenarios. A persistent RS is a SIP dialog that is set up between the SRC and the SRS, even before any CS is set up. The metadata sent from the SRC to the SRS when the persistent RS SIP dialog is set up may not have any CS (and the related CS-Group) elements in the XML, as there may not be a session that is associated to the RS yet. For example, a phone acting as an SRC can set up an RS with the SRS, possibly even before the phone is part of a CS. Once the phone joins a CS, the same RS would be used to convey the CS metadata.

6.2. Communication Session Group

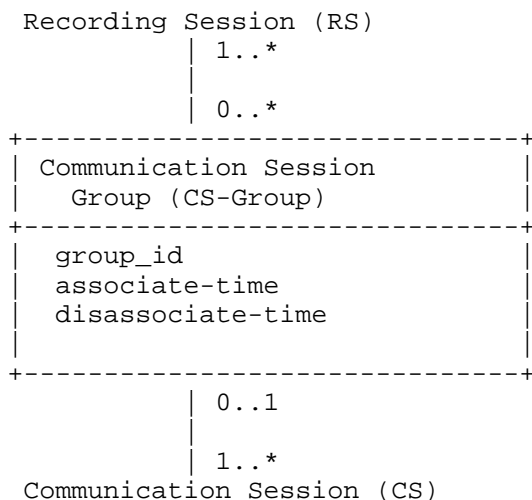

One instance of a CS-Group class, namely the CS-Group object, provides association or grouping of all related CSs. For example, in a contact center flow, a call can get transferred to multiple agents. Each of these can trigger the setup of a new CS. In cases where the SRC knows the related CSs, it can group them using the CS-Group element. The CS-Group object is represented in the XML schema using the 'group' element.

6.2.1. Attributes

A CS-Group has the following attributes:

- o `group_id` - This attribute groups different CSs that are related. The SRC (or the SRS) is responsible for ensuring the uniqueness of 'group_id' in cases where multiple SRCs interact with the same SRS. The mechanism by which the SRC groups the CS is outside the scope of this document.
- o `associate-time` - This is the time when a grouping is formed. The rules that determine how a grouping of different CS objects is done by the SRC are outside the scope of this document.
- o `disassociate-time` - 'disassociate-time' for the CS-Group is calculated by the SRC as the time when the grouping ends.

6.2.2. Linkages

The linkages between a CS-Group class and other classes are associations. A CS-Group is associated with the RS and CS in the following manner:

- o There are one or more RS objects per CS-Group.
- o Each CS-Group object has to be associated with one or more RSs. Here, each RS can be set up by the potentially different SRCs.
- o There are one or more CSs per CS-Group (for example, in cases where the call is transferred). A CS cannot be associated with more than one CS-Group.

6.3. Communication Session

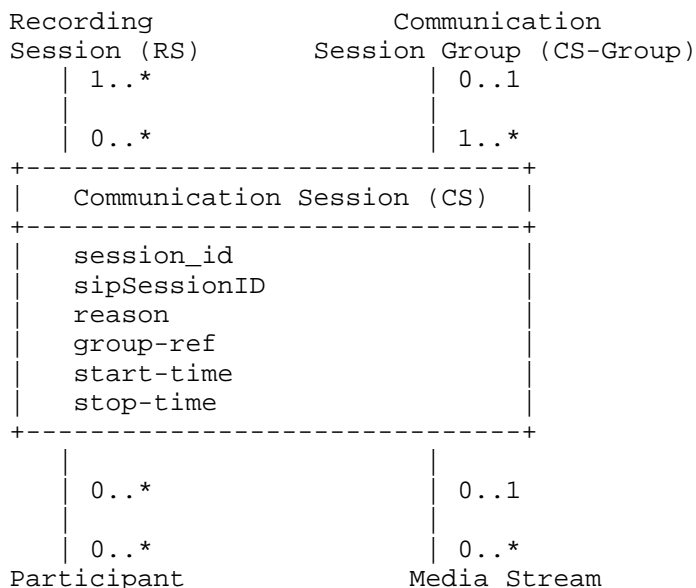

A CS class and its object in the metadata model represent the CS and its properties as seen by the SRC. The CS object is represented in the XML schema using the 'session' element.

6.3.1. Attributes

A CS class has the following attributes:

- o session_id - This attribute is used to uniquely identify an instance of a CS object, namely the 'session' XML element within the metadata XML document. 'session_id' is generated using the rules mentioned in Section 6.10.
- o reason - This represents the reason why a CS was terminated. The value for this attribute is derived from the SIP Reason header [RFC3326] of the CS. There MAY be multiple instances of the 'reason' XML element inside a 'session' element. The 'reason' XML element has 'protocol' as an attribute, which indicates the protocol from which the reason string is derived. The default value for the 'protocol' attribute is "SIP". The 'reason' element can be derived from a SIP Reason header in the CS.

- o sipSessionID - This attribute carries a SIP Session-ID as defined in [SessionID]. Each CS object can have zero or more 'sipSessionID' elements. More than one 'sipSessionID' attribute may be present in a CS. For example, if three participants -- A, B, and C -- are in a conference that has a focus acting as an SRC, the metadata sent from the SRC to the SRS will likely have three 'sipSessionID' elements that correspond to the SIP dialogs that the focus has with each of the three participants.
- o group-ref - A 'group-ref' attribute MAY be present to indicate the group (identified by 'group_id') to which the enclosing session belongs.
- o start-time - This optional attribute represents the start time of the CS as seen by the SRC.
- o stop-time - This optional attribute represents the stop time of the CS as seen by the SRC.

This document does not specify attributes relating to what should happen to a recording of a CS after it has been delivered to the SRS (e.g., how long to retain the recording, what access controls to apply). The SRS is assumed to behave in accordance with its local policy. The ability of the SRC to influence this policy is outside the scope of this document. However, if there are implementations where the SRC desires to specify its own policy preferences, this information could be sent as extension data attached to the CS.

6.3.2. Linkages

A CS is linked to the CS-Group, participant, MediaStream (MS), and RS classes by using the association relationship. The association between the CS and the participant allows the following:

- o A CS will have zero or more participants.
- o A participant is associated with zero or more CSs. This includes participants who are not directly part of any CS. An example of such a case is participants in a pre-mixed media stream. The SRC may have knowledge of such participants but not have any signaling relationship with them. This might arise if one participant in a CS is a conference focus. To summarize, even if the SRC does not have direct signaling relationships with all participants in a CS, it should nevertheless create a participant object for each participant that it knows about.

- o The model also allows participants in a CS that are not participants in the media. An example is the identity of a Third Party Call Control (3pcc) that has initiated a CS to two or more participants in the CS. Another example is the identity of a conference focus. Of course, a focus is probably in the media, but since it may only be there as a mixer, it may not report itself as a participant in any of the media streams.

The association between the CS and the media stream allows the following:

- o A CS will have zero or more streams.
- o A stream can be associated with at most one CS. A stream in a persistent RS is not required to be associated with any CS before the CS is created, and hence the zero association is allowed.

The association between the CS and the RS allows the following:

- o Each instance of an RS has zero or more instances of CS objects.
- o Each CS has to be associated with one or more RSs. Each RS can be potentially set up by different SRCs.

6.4. CS-RS Association

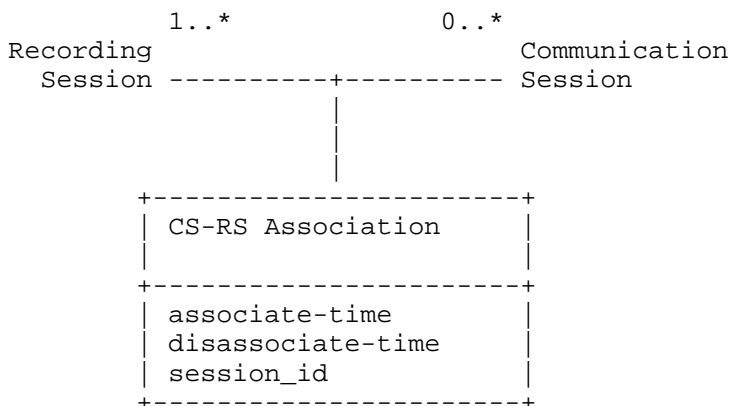

The CS-RS Association class describes the association of a CS to an RS for a period of time. A single CS may be associated with different RSs (perhaps by different SRCs) and may be associated and dissociated several times.

The CS-RS Association class is represented in XML using the 'sessionrecordingassoc' XML element.

6.4.1. Attributes

The CS-RS Association class has the following attributes:

- o associate-time - associate-time is calculated by the SRC as the time it sees a CS associated to an RS.
- o disassociate-time - disassociate-time is calculated by the SRC as the time it sees a CS disassociate from an RS.
- o session_id - Each instance of this class MUST have a 'session_id' attribute that identifies the CS to which this association belongs.

6.4.2. Linkages

The CS-RS Association class is linked to the CS and RS classes.

6.5. Participant

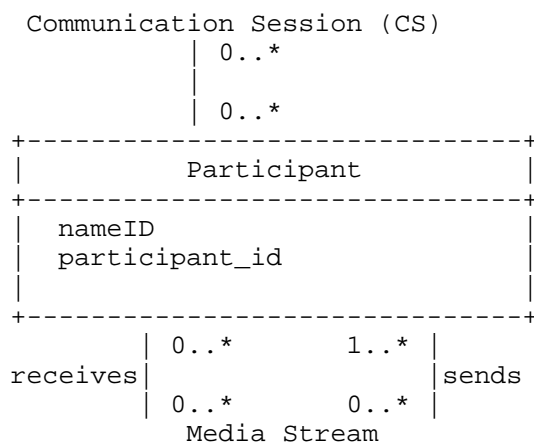

A participant class and its objects have information about a device that is part of a CS and/or contributes/consumes media stream(s) belonging to a CS.

The participant object is represented in the XML schema using the 'participant' element.

6.5.1. Attributes

A participant class has two attributes:

- o nameID - This attribute is a list of (Name, AoR) tuples. An AoR (Section 6 of [RFC3261]) can be either a SIP/SIPS/tel URI ("SIPS" means "SIP Secure"; the tel URI is discussed in [RFC3966]), a Fully Qualified Domain Name (FQDN), or an IP address. For example, the AoR may be drawn from the From header field or the P-Asserted-Identity header [RFC3325] field. The SRC's local policy is used to decide where to draw the AoR from. The Name parameter represents the participant name (SIP display name) or dialed number (when known). Multiple tuples are allowed for cases where a participant has more than one AoR. For example, a P-Asserted-Identity header can have both SIP and tel URIs.
- o participant_id - This attribute is used to identify the 'participant' XML element within the XML document. It is generated using the rules mentioned in Section 6.10. This attribute MUST be used for all references to a participant within a CS-Group, and MAY be used to reference the same participant more globally.

This document does not specify other attributes relating to participants (e.g., participant role, participant type). An SRC that has information regarding these attributes can provide this information as part of extension data to the 'participant' XML element from the SRC to the SRS.

6.5.2. Linkages

The participant class is linked to the MS and CS classes by using an association relationship. The association between the participant and the MS allows the following:

- o A participant will receive zero or more media streams.
- o A participant will send zero or more media streams. (The same participant provides multiple streams, e.g., audio and video.)

- o A media stream will be received by zero or more participants. It is possible, though perhaps unlikely, that a stream is generated but sent only to the SRC and SRS, not to any participant -- for example, in conferencing where all participants are on hold and the SRC is collocated with the focus. Also, a media stream may be received by multiple participants (e.g., "whisper" calls, side conversations).
- o A media stream will be sent by one or more participants (pre-mixed streams).

An example of a case where a participant receives zero or more streams is where a supervisor may have a side conversation with an agent while the agent converses with a customer.

6.6. Participant-CS Association

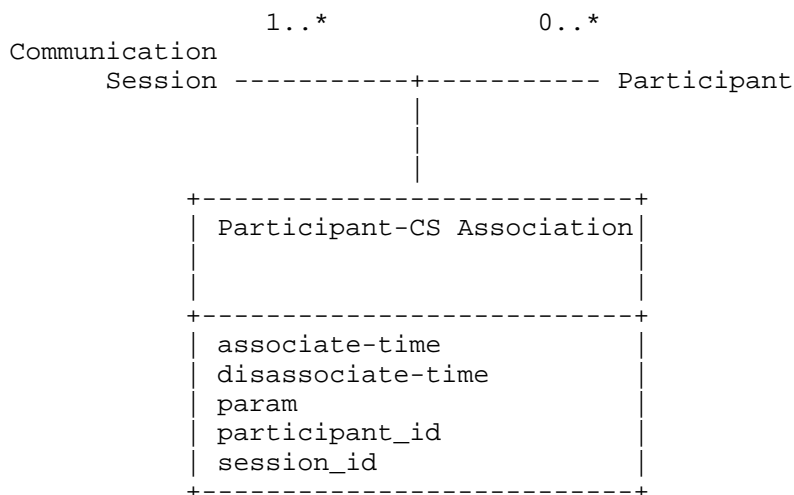

The Participant-CS Association class describes the association of a participant to a CS for a period of time. A participant may be associated to and dissociated from a CS several times (for example, connecting to a conference, then disconnecting, then connecting again).

The Participant-CS Association object is represented in the XML schema using the 'participantsessionassoc' element.

6.6.1. Attributes

The Participant-CS Association class has the following attributes:

- o associate-time - associate-time is calculated by the SRC as the time it sees a participant associated to a CS.
- o disassociate-time - disassociate-time is calculated by the SRC as the time it sees a participant disassociate from a CS. It is possible that a given participant can have multiple associate times / disassociate times within a given communication session.
- o param - The capabilities here are those that are indicated in the Contact header as defined in Section 9 of [RFC3840]. For example, in a CS (which can be a conference), you can have participants who are playing the role of "focus". These participants do not contribute to media in the CS; however, they switch the media received from one participant to every other participant in the CS. Indicating the capabilities of the participants (here, "focus") would be useful for the recorder to learn about these kinds of participants. The capabilities are represented using the 'param' XML element in the metadata. The 'param' XML element encoding defined in [RFC4235] is used to represent the capability attributes in metadata. Each participant may have zero or more capabilities. A participant may use different capabilities, depending on the role it plays at a particular instance -- for example, if a participant moves across different CSs (e.g., due to transfer) or is simultaneously present in different CSs with different roles.
- o participant_id - This attribute identifies the participant to which this association belongs.
- o session_id - This attribute identifies the session to which this association belongs.

6.6.2. Linkages

The Participant-CS Association class is linked to the participant and CS classes.

6.7. Media Stream

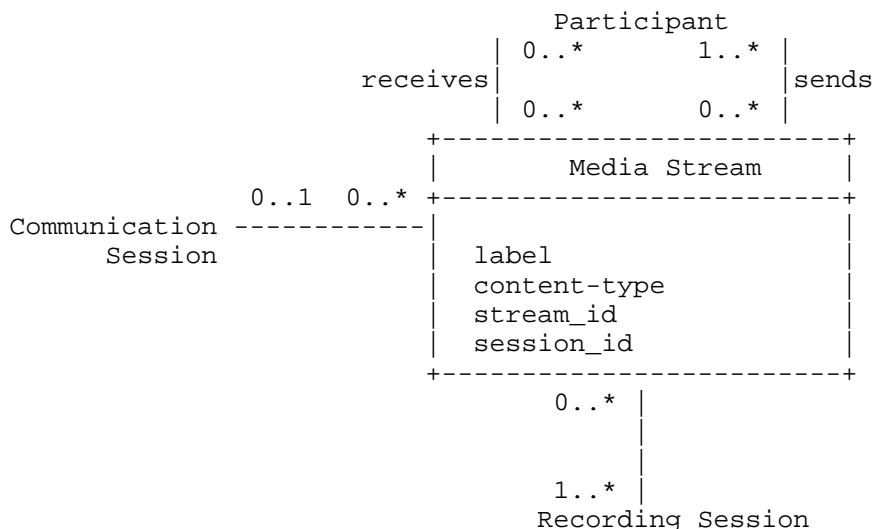

A MS class (and its objects) has the properties of media as seen by the SRC and sent to the SRS. Different snapshots of MS objects may be sent whenever there is a change in media (e.g., a direction change, like pause/resume, codec change, and/or participant change).

The MS object is represented in the XML schema using the 'stream' element.

6.7.1. Attributes

A MS class has the following attributes:

- o label - The 'label' attribute within the 'stream' XML element references an SDP "a=label" attribute that identifies an m-line within the RS SDP. That m-line carries the media stream from the SRC to the SRS.
- o content-type - The content of a MS element will be described in terms of the "a=content" attribute defined in Section 5 of [RFC4796]. If the SRC wishes to convey the content-type to the SRS, it does so by including an "a=content" attribute with the m-line in the RS SDP.

- o stream_id - Each 'stream' element has a unique 'stream_id' attribute that helps to uniquely identify the stream. This identifier is generated using the rules mentioned in Section 6.10.
- o session_id - This attribute associates the stream with a specific 'session' element.

The metadata model can include media streams that are not being delivered to the SRS. For example, an SRC offers audio and video towards an SRS that accepts only audio in response. The metadata snapshots sent from the SRC to the SRS can continue to indicate the changes to the video stream as well.

6.7.2. Linkages

A MS class is linked to the participant and CS classes by using the association relationship. Details regarding associations with the participant are described in Section 6.5. Details regarding associations with the CS are mentioned in Section 6.3.

6.8. Participant-Stream Association

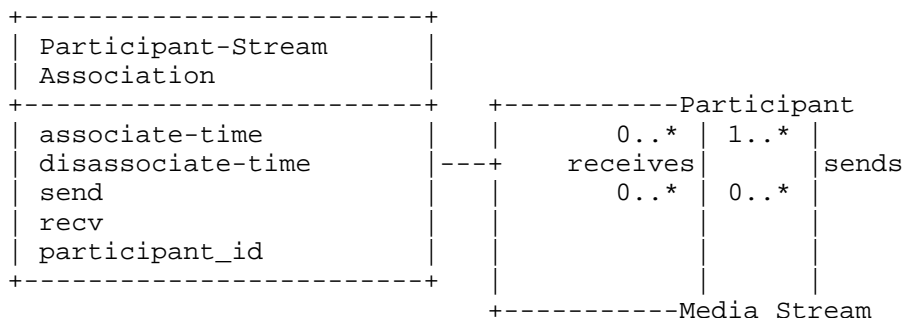

A Participant-Stream Association class describes the association of a participant to a MS for a period of time, as a sender or as a receiver, or both.

This class is represented in XML using the 'participantstreamassoc' element.

6.8.1. Attributes

A Participant-Stream Association class has the following attributes:

- o associate-time - This attribute indicates the time a participant started contributing to a MS.
- o disassociate-time - This attribute indicates the time a participant stopped contributing to a MS.
- o send - This attribute indicates whether a participant is contributing to a stream or not. This attribute has a value that points to a stream represented by its unique_id. The presence of this attribute indicates that a participant is contributing to a stream. If a participant stops contributing to a stream due to changes in a CS, a snapshot MUST be sent from the SRC to the SRS with no 'send' element for that stream.
- o recv - This attribute indicates whether a participant is receiving a media stream or not. This attribute has a value that points to a stream represented by its unique_id. The presence of this attribute indicates that a participant is receiving a stream. If the participant stops receiving a stream due to changes in a CS (like hold), a snapshot MUST be sent from the SRC to the SRS with no 'recv' element for that stream.
- o participant_id - This attribute points to the participant with which a 'stream' element is associated.

The 'participantstreamassoc' XML element is used to represent a participant association with a stream. The 'send' and 'recv' XML elements MUST be used to indicate whether a participant is contributing to a stream or receiving a stream. There MAY be multiple instances of the 'send' and 'recv' XML elements inside a 'participantstreamassoc' element. If a metadata snapshot is sent with a 'participantstreamassoc' element that does not have any 'send' and 'recv' elements, it means that the participant is neither contributing to any streams nor receiving any streams.

6.8.2. Linkages

The Participant-Stream Association class is linked to the participant and MS classes.

6.9. Syntax of XML Elements for Date and Time

The XML elements 'associate-time', 'disassociate-time', 'start-time', and 'stop-time' contain strings representing the date and time. The value of these elements MUST follow the Instant Messaging and Presence Protocol (IMPP) date-time format [RFC3339]. Timestamps that contain "T" or "Z" MUST use the capitalized forms.

As a security measure, the 'timestamp' element MUST be included in all tuples, unless the exact time of the status change cannot be determined.

6.10. Format of Unique ID

A unique_id is generated in two steps:

- o The Universally Unique Identifier (UUID) is created using any of the procedures mentioned in Sections 4.3, 4.4, and 4.5 of [RFC4122]. The algorithm MUST ensure that it does not use any potentially personally identifying information to generate the UUIDs. If implementations are using a Name-Based UUID as defined in Section 4.3 of [RFC4122], a namespace ID generated using the guidance in Section 4.2 or 4.5 of [RFC4122] might be a good choice.
- o The UUID is encoded using base64 as defined in [RFC4648].

The above-mentioned unique_id mechanism SHOULD be used for each metadata element. Multiple SRCs can refer to the same element/UUID (how each SRC learns the UUID here is beyond the scope of this document). If two SRCs use the same UUID, they MUST retain the UUID/element mapping. If the SRS detects that a UUID is mapped to more than one element at any point in time, it MUST treat this as an error. For example, the SRS may choose to reject or ignore the portions of metadata where it detects that the same UUID is mapped to an element that is different than the expected element (the SRS learns the mapped UUID when it sees an element for the first time in a metadata instance).

6.11. Metadata Version Indicator

The Metadata version is defined to help the SRC and SRS know the version of metadata XML schema used. SRCs and SRSs that support this specification MUST use version 1 in the namespace (urn:ietf:params:xml:ns:recording:1) in all the XML documents. Implementations may not interoperate if the version implemented by the sender is not known by the receiver. No negotiation of versions is provided. The version number has no significance, although

documents that update or obsolete this document (possibly including drafts of such documents) should include a higher version number if the metadata XML schema changes.

7. Recording Metadata Snapshot Request Format

The SRS can explicitly request a metadata snapshot from the SRC. To request a metadata snapshot, the SRS MUST send a SIP request message with an XML document having the namespace `urn:ietf:params:xml:ns:recording:1`. The XML document has the following elements:

- o A 'requestsnapshot' XML element MUST be present as the top-level element in the XML document.
- o A 'requestreason' XML element that indicates the reason (as a string) for requesting the snapshot MAY be present as a child XML element of 'requestsnapshot'.

The example below shows a metadata snapshot request from the SRS.

```
<?xml version="1.0" encoding="UTF-8"?>
  <requestsnapshot xmlns='urn:ietf:params:xml:ns:recording:1'>
    <requestreason xml:lang="it">SRS internal error</requestreason>
  </requestsnapshot>
```

Example Metadata Snapshot Request from SRS to SRC

8. SIP Recording Metadata Examples

8.1. Complete SIP Recording Metadata Example

The following example provides all the tuples involved in the recording metadata XML body.

```
<?xml version="1.0" encoding="UTF-8"?>
  <recording xmlns='urn:ietf:params:xml:ns:recording:1'>
    <datamode>complete</datamode>
    <group group_id="7+OTCyoxTmqmqyA/1weDAG==">
      <associate-time>2010-12-16T23:41:07Z</associate-time>
      <!-- Standardized extension -->
      <call-center xmlns='urn:ietf:params:xml:ns:callcenter'>
        <supervisor>sip:alice@atlanta.com</supervisor>
      </call-center>
      <mydata xmlns='http://example.com/my'>
        <structure>FOO!</structure>
        <whatever>bar</whatever>
      </mydata>
    </group>
    <session session_id="hVpd7YQgRW2nD22h7q60JQ==">
      <sipSessionID>ab30317f1a784dc48ff824d0d3715d86;
remote=47755a9de7794ba387653f2099600ef2</sipSessionID>
      <group-ref>7+OTCyoxTmqmqyA/1weDAG==</group-ref>
      <!-- Standardized extension -->
      <mydata xmlns='http://example.com/my'>
        <structure>FOO!</structure>
        <whatever>bar</whatever>
      </mydata>
    </session>
    <participant participant_id="srfBEImCRp2QB23b7Mpk0w==">
      <nameID aor="sip:bob@biloxi.com">
        <name xml:lang="it">Bob</name>
      </nameID>
      <!-- Standardized extension -->
      <mydata xmlns='http://example.com/my'>
        <structure>FOO!</structure>
        <whatever>bar</whatever>
      </mydata>
    </participant>
```

```
<participant participant_id="zSfPoSvdSDCmU3A3TRDxAw==">
  <nameID aor="sip:Paul@biloxi.com">
    <name xml:lang="it">Paul</name>
  </nameID>
  <!-- Standardized extension -->
  <mydata xmlns='http://example.com/my'>
    <structure>FOO!</structure>
    <whatever>bar</whatever>
  </mydata>
</participant>
<stream stream_id="UAAMm5GRQKSCMVvLy14rFw=="
  session_id="hVpd7YQgRW2nD22h7q60JQ==">
  <label>96</label>
</stream>
<stream stream_id="ilPz3to5hGk8fuXl+PbwCw=="
  session_id="hVpd7YQgRW2nD22h7q60JQ==">
  <label>97</label>
</stream>
<stream stream_id="8zc6e0lYTlWIINA6GR+3ag=="
  session_id="hVpd7YQgRW2nD22h7q60JQ==">
  <label>98</label>
</stream>
<stream stream_id="EiXGlc+4TruqqoDaNE76ag=="
  session_id="hVpd7YQgRW2nD22h7q60JQ==">
  <label>99</label>
</stream>
<sessionrecordingassoc session_id="hVpd7YQgRW2nD22h7q60JQ==">
  <associate-time>2010-12-16T23:41:07Z</associate-time>
</sessionrecordingassoc>
<participantsessionassoc
  participant_id="srfBEImCRp2QB23b7Mpk0w=="
  session_id="hVpd7YQgRW2nD22h7q60JQ==">
  <associate-time>2010-12-16T23:41:07Z</associate-time>
</participantsessionassoc>
<participantsessionassoc
  participant_id="zSfPoSvdSDCmU3A3TRDxAw=="
  session_id="hVpd7YQgRW2nD22h7q60JQ==">
  <associate-time>2010-12-16T23:41:07Z</associate-time>
</participantsessionassoc>
```



```

<participantstreamassoc
  participant_id="srfBEImCRp2QB23b7Mpk0w==">
  <send>ilPz3to5hGk8fuXl+PbwCw==</send>
  <send>UAAMm5GRQKSCMVvLy14rFw==</send>
  <recv>8zc6e0lYtLWIINA6GR+3ag==</recv>
  <recv>EiXGlc+4TruqqoDaNE76ag==</recv>
</participantstreamassoc>
<participantstreamassoc
  participant_id="zSfPoSvdSDCmU3A3TRDxAw==">
  <send>8zc6e0lYtLWIINA6GR+3ag==</send>
  <send>EiXGlc+4TruqqoDaNE76ag==</send>
  <recv>UAAMm5GRQKSCMVvLy14rFw==</recv>
  <recv>ilPz3to5hGk8fuXl+PbwCw==</recv>
</participantstreamassoc>
</recording>

```

Example Metadata Snapshot from SRC to SRS

8.2. Partial Update of Recording Metadata XML Body

The following example provides a partial update in the recording metadata XML body for the above example. The example has a snapshot that carries the disassociate-time for a participant from a session.

```

<?xml version="1.0" encoding="UTF-8"?>
<recording xmlns='urn:ietf:params:xml:ns:recording:1'>
  <datamode>partial</datamode>
  <participant
    participant_id="srfBEImCRp2QB23b7Mpk0w==">
    <nameID aor="sip:bob@biloxi.com">
      <name xml:lang="it">Bob</name>
    </nameID>
  </participant>
  <participantsessionassoc
    participant_id="srfBEImCRp2QB23b7Mpk0w=="
    session_id="hVpd7YQgRW2nD22h7q60JQ==">
    <disassociate-time>2010-12-16T23:41:07Z</disassociate-time>
  </participantsessionassoc>
</recording>

```

Partial Update of SIP Recording Example XML Body

9. XML Schema Definition for Recording Metadata

This section defines the XML schema for the recording metadata document.

```
<?xml version="1.0" encoding="UTF-8"?>
<xs:schema targetNamespace="urn:ietf:params:xml:ns:recording:1"
  xmlns:xs="http://www.w3.org/2001/XMLSchema"
  xmlns:tns="urn:ietf:params:xml:ns:recording:1"
  elementFormDefault="qualified"
  attributeFormDefault="unqualified">
  <!-- This import brings in the XML language attribute xml:lang -->
  <xs:import namespace="http://www.w3.org/XML/1998/namespace"
    schemaLocation="https://www.w3.org/2001/xml.xsd"/>
  <xs:element name="recording" type="tns:recording"/>
  <xs:complexType name="recording">
    <xs:sequence>
      <xs:element name="datamode" type="tns:dataMode"
        minOccurs="0"/>
      <xs:element name="group" type="tns:group"
        minOccurs="0" maxOccurs="unbounded"/>
      <xs:element name="session" type="tns:session"
        minOccurs="0" maxOccurs="unbounded"/>
      <xs:element name="participant" type="tns:participant"
        minOccurs="0" maxOccurs="unbounded"/>
      <xs:element name="stream" type="tns:stream"
        minOccurs="0" maxOccurs="unbounded"/>
      <xs:element name="sessionrecordingassoc"
        type="tns:sessionrecordingassoc"
        minOccurs="0" maxOccurs="unbounded"/>
      <xs:element name="participantsessionassoc"
        type="tns:participantsessionassoc"
        minOccurs="0" maxOccurs="unbounded"/>
      <xs:element name="participantstreamassoc"
        type="tns:participantstreamassoc"
        minOccurs="0" maxOccurs="unbounded"/>
      <xs:any namespace='##other'
        minOccurs='0'
        maxOccurs='unbounded'
        processContents='lax'/>
    </xs:sequence>
  </xs:complexType>
</xs:schema>
```

```
<xs:complexType name="group">
  <xs:sequence>
    <xs:element name="associate-time" type="xs:dateTime"
      minOccurs="0"/>
    <xs:element name="disassociate-time" type="xs:dateTime"
      minOccurs="0"/>
    <xs:any namespace='##other'
      minOccurs='0'
      maxOccurs='unbounded'
      processContents='lax'/>
  </xs:sequence>
  <xs:attribute name="group_id" type="xs:base64Binary"
    use="required"/>
</xs:complexType>
<xs:complexType name="session">
  <xs:sequence>
    <xs:element name="sipSessionID" type="xs:string"
      minOccurs="0" maxOccurs="unbounded"/>
    <xs:element name="reason" type="tns:reason"
      minOccurs="0" maxOccurs="unbounded"/>
    <xs:element name="group-ref" type="xs:base64Binary"
      minOccurs="0" maxOccurs="1"/>
    <xs:element name="start-time" type="xs:dateTime"
      minOccurs="0" maxOccurs="1"/>
    <xs:element name="stop-time" type="xs:dateTime"
      minOccurs="0" maxOccurs="1"/>
    <xs:any namespace='##other'
      minOccurs='0'
      maxOccurs='unbounded'
      processContents='lax'/>
  </xs:sequence>
  <xs:attribute name="session_id" type="xs:base64Binary"
    use="required"/>
</xs:complexType>
<xs:complexType name="sessionrecordingassoc">
  <xs:sequence>
    <xs:element name="associate-time" type="xs:dateTime"
      minOccurs="0"/>
    <xs:element name="disassociate-time" type="xs:dateTime"
      minOccurs="0"/>
    <xs:any namespace='##other'
      minOccurs='0'
      maxOccurs='unbounded'
      processContents='lax'/>
  </xs:sequence>
  <xs:attribute name="session_id" type="xs:base64Binary"
    use="required"/>
</xs:complexType>
```

```
<xs:complexType name="participant">
  <xs:sequence>
    <xs:element name="nameID" type="tns:nameID"
      maxOccurs='unbounded' />
    <xs:any namespace='##other'
      minOccurs='0'
      maxOccurs='unbounded'
      processContents='lax' />
  </xs:sequence>
  <xs:attribute name="participant_id" type="xs:base64Binary"
    use="required" />
</xs:complexType>
<xs:complexType name="participantsessionassoc">
  <xs:sequence>
    <xs:element name="associate-time" type="xs:dateTime"
      minOccurs="0" />
    <xs:element name="disassociate-time" type="xs:dateTime"
      minOccurs="0" />
    <xs:element name="param" minOccurs="0" maxOccurs="unbounded">
      <xs:complexType>
        <xs:attribute name="pname" type="xs:string"
          use="required" />
        <xs:attribute name="pval" type="xs:string"
          use="required" />
      </xs:complexType>
    </xs:element>
    <xs:any namespace='##other'
      minOccurs='0'
      maxOccurs='unbounded'
      processContents='lax' />
  </xs:sequence>
  <xs:attribute name="participant_id" type="xs:base64Binary"
    use="required" />
  <xs:attribute name="session_id" type="xs:base64Binary"
    use="required" />
</xs:complexType>
```

```
<xs:complexType name="participantstreamassoc">
  <xs:sequence>
    <xs:element name="send" type="xs:base64Binary"
      minOccurs="0" maxOccurs="unbounded"/>
    <xs:element name="recv" type="xs:base64Binary"
      minOccurs="0" maxOccurs="unbounded"/>
    <xs:element name="associate-time" type="xs:dateTime"
      minOccurs="0"/>
    <xs:element name="disassociate-time" type="xs:dateTime"
      minOccurs="0"/>
    <xs:any namespace='##other'
      minOccurs='0'
      maxOccurs='unbounded'
      processContents='lax'/>
  </xs:sequence>
  <xs:attribute name="participant_id" type="xs:base64Binary"
    use="required"/>
</xs:complexType>
<xs:complexType name="stream">
  <xs:sequence>
    <xs:element name="label" type="xs:string"
      minOccurs="0" maxOccurs="1"/>
    <xs:any namespace='##other'
      minOccurs='0'
      maxOccurs='unbounded'
      processContents='lax'/>
  </xs:sequence>
  <xs:attribute name="stream_id" type="xs:base64Binary"
    use="required"/>
  <xs:attribute name="session_id" type="xs:base64Binary"/>
</xs:complexType>
<xs:simpleType name="dataMode">
  <xs:restriction base="xs:string">
    <xs:enumeration value="complete"/>
    <xs:enumeration value="partial"/>
  </xs:restriction>
</xs:simpleType>
<xs:complexType name="nameID">
  <xs:sequence>
    <xs:element name="name" type="tns:name" minOccurs="0"
      maxOccurs="1"/>
  </xs:sequence>
  <xs:attribute name="aor" type="xs:anyURI" use="required"/>
</xs:complexType>
```

```
<xs:complexType name="name">
  <xs:simpleContent>
    <xs:extension base="xs:string">
      <xs:attribute ref="xml:lang" use="optional"/>
    </xs:extension>
  </xs:simpleContent>
</xs:complexType>
<xs:complexType name="reason">
  <xs:simpleContent>
    <xs:extension base="xs:string">
      <xs:attribute type="xs:short" name="cause" use="required"/>
      <xs:attribute type="xs:string" name="protocol" default="SIP"/>
    </xs:extension>
  </xs:simpleContent>
</xs:complexType>
<xs:element name="requestsnapshot" type="tns:requestsnapshot"/>
<xs:complexType name="requestsnapshot">
  <xs:sequence>
    <xs:element name="requestreason" type="tns:name"
      minOccurs="0"/>
    <xs:any namespace='##other'
      minOccurs='0'
      maxOccurs='unbounded'
      processContents='lax'/>
  </xs:sequence>
</xs:complexType>
</xs:schema>
```

10. Security Considerations

This document describes an extensive set of metadata that may be recorded by the SRS. Most of the metadata could be considered private data. The procedures mentioned in the Security Considerations section of [RFC7866] MUST be followed by the SRC and the SRS for mutual authentication and to protect the content of the metadata in the RS.

An SRC MAY, by policy, choose to limit the parts of the metadata sent to the SRS for recording. Also, the policy of the SRS might not require recording all the metadata it receives. For the sake of data minimization, the SRS MUST NOT record additional metadata that is not explicitly required by local policy. Metadata in storage needs to be provided with a level of security that is comparable to that of the recording session.

11. IANA Considerations

This specification registers a new XML namespace and a new XML schema.

11.1. SIP Recording Metadata Schema Registration

URI: urn:ietf:params:xml:ns:recording:1

Registrant Contact: IETF SIPREC working group, Ram Mohan R
(rmohanr@cisco.com)

XML: The registered XML schema is contained in Section 9.

Its first line is `<?xml version="1.0" encoding="UTF-8"?>`, and its last line is `</xs:schema>`.

12. References

12.1. Normative References

- [RFC2119] Bradner, S., "Key words for use in RFCs to Indicate Requirement Levels", BCP 14, RFC 2119, DOI 10.17487/RFC2119, March 1997, <http://www.rfc-editor.org/info/rfc2119>.
- [RFC3261] Rosenberg, J., Schulzrinne, H., Camarillo, G., Johnston, A., Peterson, J., Sparks, R., Handley, M., and E. Schooler, "SIP: Session Initiation Protocol", RFC 3261, DOI 10.17487/RFC3261, June 2002, <http://www.rfc-editor.org/info/rfc3261>.
- [RFC3339] Klyne, G. and C. Newman, "Date and Time on the Internet: Timestamps", RFC 3339, DOI 10.17487/RFC3339, July 2002, <http://www.rfc-editor.org/info/rfc3339>.
- [RFC3840] Rosenberg, J., Schulzrinne, H., and P. Kyzivat, "Indicating User Agent Capabilities in the Session Initiation Protocol (SIP)", RFC 3840, DOI 10.17487/RFC3840, August 2004, <http://www.rfc-editor.org/info/rfc3840>.
- [RFC4122] Leach, P., Mealling, M., and R. Salz, "A Universally Unique Identifier (UUID) URN Namespace", RFC 4122, DOI 10.17487/RFC4122, July 2005, <http://www.rfc-editor.org/info/rfc4122>.

- [RFC4566] Handley, M., Jacobson, V., and C. Perkins, "SDP: Session Description Protocol", RFC 4566, DOI 10.17487/RFC4566, July 2006, <<http://www.rfc-editor.org/info/rfc4566>>.
- [RFC4574] Levin, O. and G. Camarillo, "The Session Description Protocol (SDP) Label Attribute", RFC 4574, DOI 10.17487/RFC4574, August 2006, <<http://www.rfc-editor.org/info/rfc4574>>.
- [RFC4648] Josefsson, S., "The Base16, Base32, and Base64 Data Encodings", RFC 4648, DOI 10.17487/RFC4648, October 2006, <<http://www.rfc-editor.org/info/rfc4648>>.
- [RFC4796] Hautakorpi, J. and G. Camarillo, "The Session Description Protocol (SDP) Content Attribute", RFC 4796, DOI 10.17487/RFC4796, February 2007, <<http://www.rfc-editor.org/info/rfc4796>>.
- [RFC7866] Portman, L., Lum, H., Ed., Eckel, C., Johnston, A., and A. Hutton, "Session Recording Protocol", RFC 7866, DOI 10.17487/RFC7866, May 2016, <<http://www.rfc-editor.org/info/rfc7866>>.

12.2. Informative References

- [RFC3325] Jennings, C., Peterson, J., and M. Watson, "Private Extensions to the Session Initiation Protocol (SIP) for Asserted Identity within Trusted Networks", RFC 3325, DOI 10.17487/RFC3325, November 2002, <<http://www.rfc-editor.org/info/rfc3325>>.
- [RFC3326] Schulzrinne, H., Oran, D., and G. Camarillo, "The Reason Header Field for the Session Initiation Protocol (SIP)", RFC 3326, DOI 10.17487/RFC3326, December 2002, <<http://www.rfc-editor.org/info/rfc3326>>.
- [RFC3966] Schulzrinne, H., "The tel URI for Telephone Numbers", RFC 3966, DOI 10.17487/RFC3966, December 2004, <<http://www.rfc-editor.org/info/rfc3966>>.
- [RFC4235] Rosenberg, J., Schulzrinne, H., and R. Mahy, Ed., "An INVITE-Initiated Dialog Event Package for the Session Initiation Protocol (SIP)", RFC 4235, DOI 10.17487/RFC4235, November 2005, <<http://www.rfc-editor.org/info/rfc4235>>.

- [RFC6341] Rehor, K., Ed., Portman, L., Ed., Hutton, A., and R. Jain, "Use Cases and Requirements for SIP-Based Media Recording (SIPREC)", RFC 6341, DOI 10.17487/RFC6341, August 2011, <<http://www.rfc-editor.org/info/rfc6341>>.
- [RFC7245] Hutton, A., Ed., Portman, L., Ed., Jain, R., and K. Rehor, "An Architecture for Media Recording Using the Session Initiation Protocol", RFC 7245, DOI 10.17487/RFC7245, May 2014, <<http://www.rfc-editor.org/info/rfc7245>>.
- [SessionID] Jones, P., Salgueiro, G., Pearce, C., and P. Giralt, "End-to-End Session Identification in IP-Based Multimedia Communication Networks", Work in Progress, draft-ietf-insipid-session-id-22, April 2016.
- [UML] Object Management Group, "OMG Unified Modeling Language (UML)", 2011, <<http://www.omg.org/spec/UML/2.4/>>.

Acknowledgements

Thanks to John Elwell, Henry Lum, Leon Portman, De Villiers de Wet, Andrew Hutton, Deepanshu Gautam, Charles Eckel, Muthu Arul Mozhi Perumal, Michael Benenson, Hadriel Kaplan, Brian Rosen, Scott Orton, Ofir Roth, Mary Barnes, Ken Rehor, Gonzalo Salgueiro, Yaron Pdut, Alissa Cooper, Stephen Farrell, and Ben Campbell for their valuable comments and inputs.

Thanks to Joe Hildebrand, Peter Saint-Andre, and Matt Miller for helping in writing the XML schema, and to Martin Thomson for validating the XML schema and providing comments on the same.

Authors' Addresses

Ram Mohan Ravindranath
Cisco Systems
Cessna Business Park
Bangalore, Karnataka
India

Email: rmohanr@cisco.com

Parthasarathi Ravindran
Nokia Networks
Bangalore, Karnataka
India

Email: partha@parthasarathi.co.in

Paul Kyzivat
Huawei
Hudson, MA
United States

Email: pkyzivat@alum.mit.edu