

# Commodore Color Video Monitor Users Manual



Model #1702

 **commodore**

## CAUTION

If you have technical problems with your Commodore 1702 color monitor, especially if your set produces only sound with no picture, or if the viewing area shrinks to half size, unplug the set and call your dealer or service technician.

For your safety, please carefully read the SAFETY PRECAUTIONS on pages 7 and 8 in this user's manual.

## WARNING

**DO NOT EXPOSE THIS EQUIPMENT TO MOISTURE. SUCH EXPOSURE COULD CAUSE FIRE OR ELECTRIC SHOCK.**

This equipment generates and uses radio frequency energy. If it is not properly installed and used in strict accordance with the manufacturer's instructions, this equipment may interfere with radio and television reception. This machine has been tested and found to comply with the limits for a Class B computing device in accordance with the specifications in Subpart J of Part 15 of FCC Rules, which are designed to provide reasonable protection against such interference in a residential installation. If you suspect interference, you can test this equipment by turning it off and on. If you determine that there is interference with radio or television reception, try one or more of the following measures to correct it:

- reorient the receiving antenna
- move the computer and this monitor away from the receiver that is picking up interference
- change the relative positions of the computer equipment and the receiver
- plug the computer and this monitor into a different outlet so that the computer and the receiver are on different branch circuits.

If necessary, consult your Commodore dealer or an experienced radio/television technician for additional suggestions. You may also wish to consult the following booklet, which was prepared by the Federal Communications Commission: *How to Identify and Resolve Radio-TV Interference Problems*. This booklet is available from the US Government Printing Office, Washington, D.C., 20402, Stock No. 004-000-00345-4.

## INTRODUCING YOUR MONITOR

Your new Commodore 1702 color monitor gives you a superior color picture that enhances your computing experience. This monitor is simple to hook up to your computer and is easy to adjust.

Please read this brief manual carefully before you try to use your monitor. The manual shows you how to install and use the monitor correctly. It also explains how to use the picture control knobs, which are like the control knobs on a color TV.

Be sure to heed any warnings in this manual, and do NOT remove the back cover or otherwise attempt to service this monitor. If you have problems with your monitor that are not covered in this manual, see your Commodore dealer or a qualified technician.

### FRONT VIEW OF 1702 MONITOR

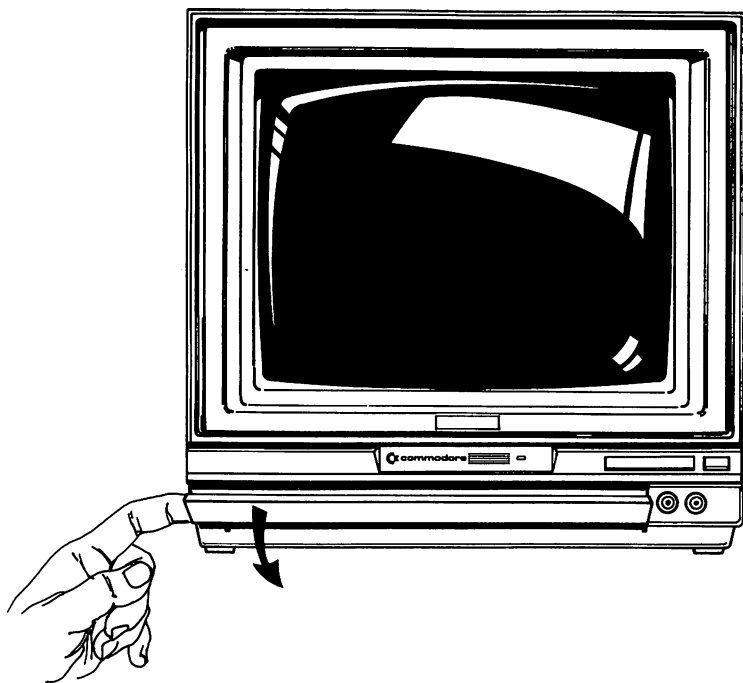

## FRONT CONTROL PANEL

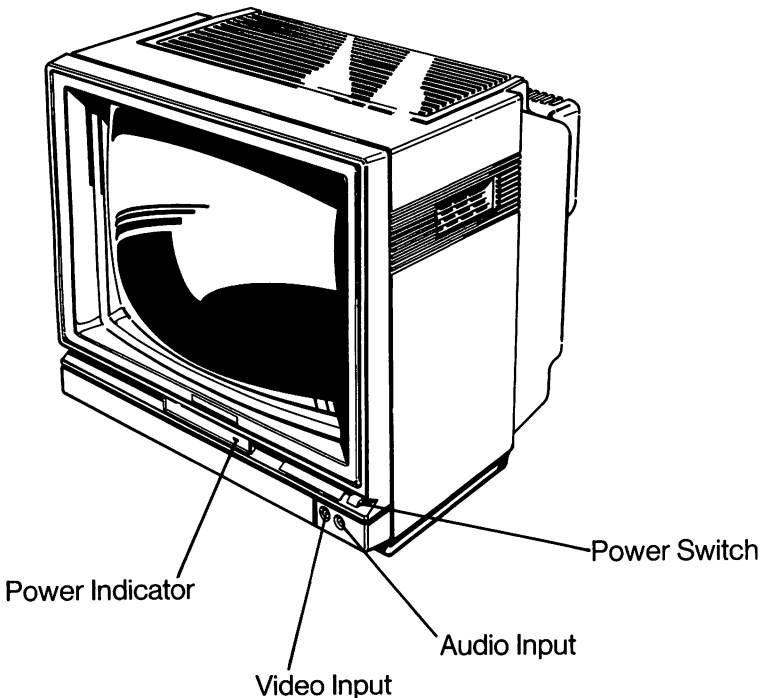

## CONNECTING THE MONITOR TO A COMPUTER

The monitor connection cable connects your monitor to a Commodore personal computer. Before you connect the cable, turn off the power to both your personal computer and the monitor.

There are two different cables that you can use to connect the monitor to your computer.

1. One kind of cable has three jacks that connect to the **BACK** of the monitor.
2. The other cable has two jacks that connect to the **FRONT** of the monitor.

The kind of cable you'll use depends on your computer. To find out which kind of cable you should use, look at the audio/video connector on your computer (see your computer's user manual if you don't know where this connector is).

1. If the audio/video connector has **EIGHT** little holes, use the three-jack cable.
2. If the connector has **FIVE** little holes, use the two-jack cable.

To connect a three-jack cable to the rear panel of the monitor, follow these instructions, which clarify the diagram:

1. Plug the eight PIN DIN connector (the larger end of the cable) into the audio/video connector port on your computer. Just push the cable end in.
2. Plug the RCA pin plugs (the jacks) of the cable into the rear terminals on the monitor. The jacks and the terminals are color-coded:
  - the audio output jack (WHITE) plugs into the AUDIO IN terminal (WHITE) on the monitor
  - the luminance output jack (YELLOW) plugs into the LUMA terminal (YELLOW)
  - the chroma output jack (RED) plugs into the CHROMA terminal (RED)
3. Switch the SIGNAL SELECTOR to the REAR position.

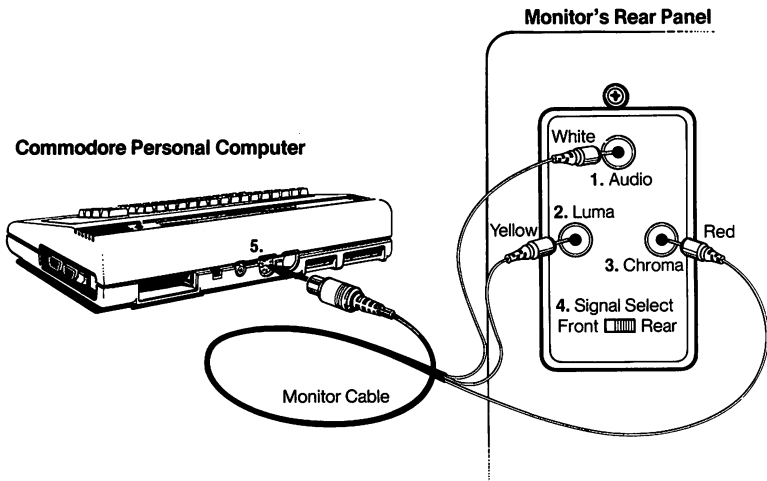

1. Monitor's Audio Input (White)
2. Luminance Input (Yellow)
3. Chroma Input (Red)
4. Signal Selector  
Front  Rear
5. Computer's Audio/Video Connector

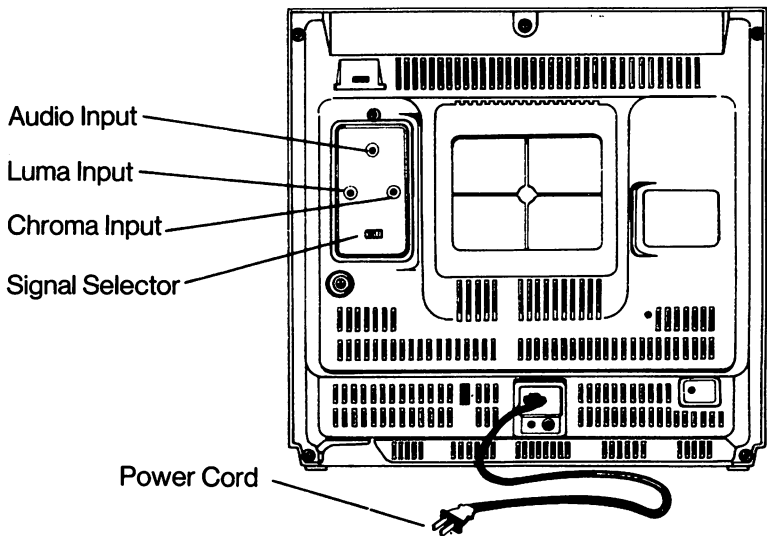

To connect a two-jack cable to the front of the monitor, follow these steps:

1. Plug the five PIN DIN connector (the larger end of the cable) into the audio/video connector port on your computer. Just push the cable in.
2. Plug the VIDEO IN and AUDIO IN jacks into the VIDEO INPUT and AUDIO INPUT terminals on the front of the monitor under the screen.
3. Switch the SIGNAL SELECTOR to the FRONT position. The SIGNAL SELECTOR is a switch on the REAR PANEL.

After you follow these simple steps, your 1702 is ready for use as a video monitor for your personal computer.

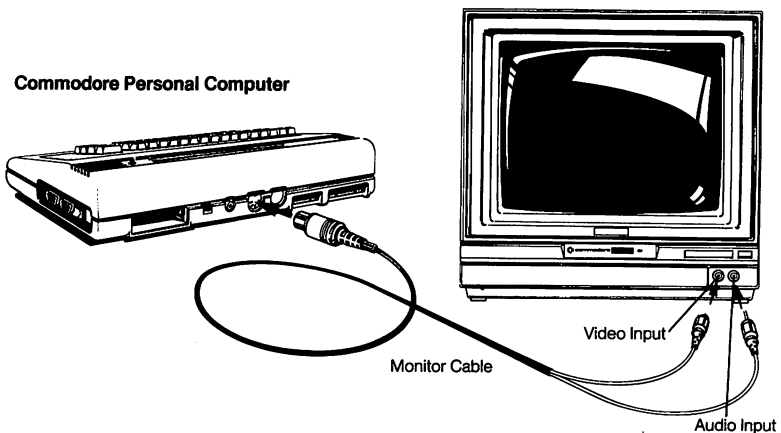

## TURNING ON YOUR MONITOR

When you finish connecting your monitor according to the instructions, follow these simple steps:

1. Turn on the monitor by pushing down the power switch. The **POWER INDICATOR LIGHT** on the front of the monitor shows you when the power is on. Always turn on the monitor **BEFORE** you turn on the computer.

Later, when you're ready to turn the power off, just press the power button again. The button will pop back up and the power light will go out.

2. Turn on your personal computer. You can tell that both the monitor and the computer are working correctly when the monitor displays a message like this one, which appears when you're using a Commodore 64:

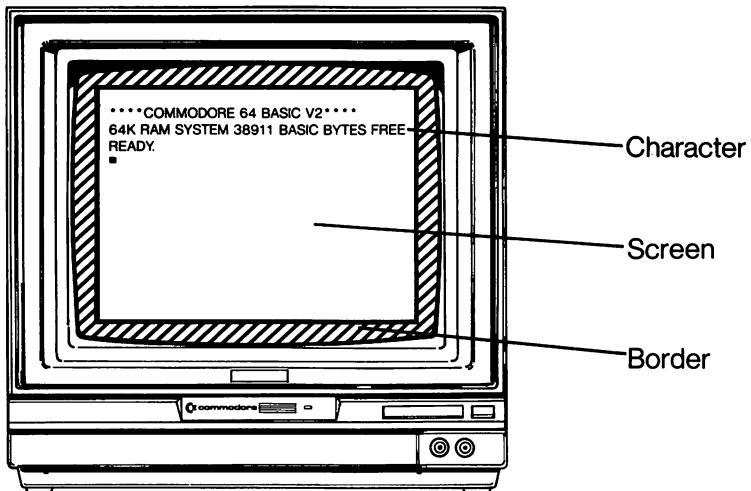

Different computers display other opening messages. If you don't know what message to expect, see your computer's user manual.

## USING THE MANUAL PICTURE CONTROLS

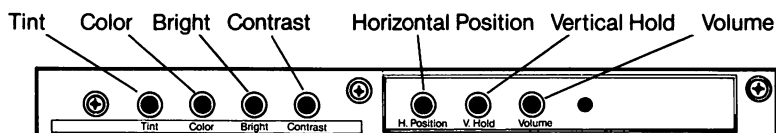

You can adjust your monitor's picture with the seven manual control buttons located behind the panel beneath the monitor screen. The panel opens from the top; just flip open the cover by releasing it at the top.

### TINT CONTROL

Turn this knob to the left to add more red, and to the right to add more green color.

The normal setting for this knob is at the center, which is the click-stop position.

When you're adjusting the color, concentrate on one or two colors, such as brown and purple.

### COLOR CONTROL

Turn this knob to the left to pale colors, and to the right to brighten colors. The normal setting is at the center, which is the click-stop position.

### BRIGHTNESS CONTROL

Turn this knob to the right to brighten the picture. The normal setting is at the center.

### CONTRAST CONTROL

Turn this knob to the right to increase contrast. The normal setting is at the center.

### HORIZONTAL POSITION CONTROL

Turn this knob to the right to move the center of the picture to the right, and turn it to the left to move the center of the picture to the left.

### VERTICAL POSITION CONTROL

Turn this knob to stop vertical rolling of the picture.

### VOLUME CONTROL

Turn this knob to the right to increase sound volume and to the left to decrease volume.



## SAFETY PRECAUTIONS

Electrical energy can perform many useful functions. This unit has been engineered and manufactured to assure your personal safety. But **improper use can result in potential electrical shock or fire hazards**. In order not to defeat the safeguards incorporated in this monitor, observe the following basic rules for its installation, use and servicing. And also follow all warnings and instructions marked on your video monitor.

### INSTALLATION

1. Your set is equipped with a polarized AC line plug (one blade of the plug is wider than the other).

This safety feature allows the plug to fit into the power outlet only one way. Should you be unable to insert the plug fully into the outlet, try reversing the plug. Should it still fail to fit, contact your electrician.

2. Operate the set only from a power source as indicated on the set or refer to the user's manual for this information. If you are not sure of the type of power supply to your home, consult your dealer or local power company.
3. Overloaded AC outlets and extension cords are dangerous, and so are frayed power cords and broken plugs. They may result in a shock or fire hazard. Call your service technician for replacement.
4. Do not allow anything to rest or roll over the power cord, and do not place the set where power cord is subject to traffic or abuse. This may result in a shock or fire hazard.
5. Do not use this set near water — for example, near a bathtub, washbowl, kitchen sink, or laundry tub, in a wet basement, or near a swimming pool, etc.
6. Sets are provided with ventilation openings in the cabinet to allow heat generated during operation to be released. If these openings are blocked, heat built up within the set can cause failures which may result in a fire hazard. Therefore:
  - **Never block the bottom ventilation slots by placing it on a bed, sofa, rug, etc.;**
  - **Never place a set in a "built-in" enclosure unless proper ventilation is provided;**
  - **Never cover the openings with cloth or other material;**
  - **Never place the set near or over a radiator or heat register.**
7. To avoid personal injury:
  - Do not place a set on a sloping shelf unless properly secured;

- Use only a cart or stand recommended by the manufacturer;
- Do not try to roll a cart with small casters across thresholds or deep pile carpets.
- Wall and shelf mounted installations should use factory approved mounting instructions.

## USE

8. Always turn the set off if it is necessary to leave the room for more than a short period of time. Never leave a set on when leaving the house. A possible malfunction may result in a fire hazard.
9. Caution children about dropping or pushing objects into the set's cabinet openings. Some internal parts carry hazardous voltages and contact can result in a fire or electrical shock.
10. Unplug the set from the wall outlet before cleaning the face of the picture tube. Use a slightly damp (not wet) cloth. Do not use an aerosol directly on the picture tube since it may overspray and cause electrical shock.
11. Never add accessories to a set that has not been designed for this purpose. Such additions may result in a shock hazard.
12. For added protection of the set during a lightning storm or when the set is to be left unattended for an extended period of time, unplug it from the wall outlet. This will prevent possible shock and fire hazards due to lightning storms or power line surges.
13. Do not bring magnetic devices such as magnets or motors near the picture tube. These things have a bad effect on the color purity of the picture.
14. Sometimes you may feel static electricity when you touch the surface of the picture tube. However, this is normal for any TV set and is harmless to the human body.

## SERVICE

15. Unplug the set from the wall outlet and refer servicing to qualified service personnel under the following conditions:
  - A. When the power cord or plug is damaged or frayed.
  - B. If liquid has been spilled into the set.
  - C. If the set has been exposed to rain or water.
  - D. If the set does not operate normally by following the operating instructions. Adjust only those controls that are covered in the operating instructions, as improper adjustment of other controls may result in damage and will often require extensive work by a qualified technician to restore the set to normal operation.
  - E. If the set has been dropped or the cabinet has been damaged.
  - F. When the set exhibits a distinct change in performance — this indicates a need for servicing.
  - G. If snapping or popping from the set is continuous or frequent while the set is operating. It is normal for some sets to make occasional snapping or popping sounds, particularly when being turned on or off.
16. Do not attempt to service this set yourself, as opening or removing covers may expose you to dangerous voltage or other hazards. Refer all servicing to qualified service personnel.
17. When replacement parts are required, have the service technician verify in writing that the replacements he uses have the same safety characteristics as the original parts. Use of manufacturer's specified replacements can prevent fire, shock, or other hazards.
18. Upon completion of any service or repairs to the set, please ask the service technician to perform the safety check described in the manufacturers' service literature.
19. When a video monitor reaches the end of its useful life, improper disposal could result in a picture tube implosion. Ask a qualified service technician to dispose of the set.



1200 Wilson Drive  
West Chester, PA 19380

Printed in Japan  
1702-1B-B